

GCX Mounting Assembly Installation Guide

Drager Narcomed GS Anesthesia Machines with
Philips IntelliVue MP40/50/60/70, MX400/450/500/550/600/700/800 Patient Monitor Kit

Philips IntelliVue MP40/50/60/70
Or MX400/450/500/550/600/700/800
Patient Monitor

Philips M8048A Flexible
Module Server

Philips M3001A Cardiac
Measurement Server

Philips M3016A CO2
Measurement Extension



AGM

Drager Narcomed GS
Anesthesia Machine

The purpose of these instructions is to:

1. Describe attachment of GCX mounting hardware for Philips IntelliVue MP40/50/60/70, MX400/450/500/550/600/700/800 Monitor Kit to the Drager Narcomed GS Anesthesia machine.



WARNING: USE OF MOUNTING HARDWARE AND MONITORING COMPONENTS OTHER THAN THOSE DESCRIBED IN THIS DOCUMENT MAY RESULT IN SERIOUS INJURY DUE TO TIPPING OF THE ANESTHESIA MACHINE.

GS Single Counterweight Kit

1. Place the (2) Spanning Rails on the lower horizontal members of the anesthesia machine. Insert the 5/16-18 x 3" hex bolts through the counterbored holes in the Rails, through the holes in the anesthesia machine, through the holes in the lower pan, and secure them with the (4) 5/16-18 kep nuts provided.

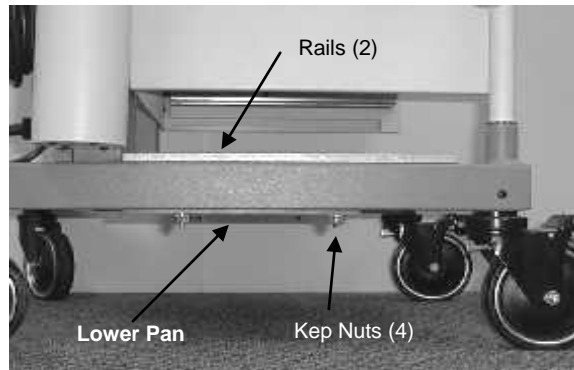

3. Insert the (2) weight bars into the lower pan. Fix them in place by running the (2) 5/16-18 x 2 1/2" or (2) 5/16-18 x 1 1/2" hex bolts through the fender washers and into the inserts in the lower pan.

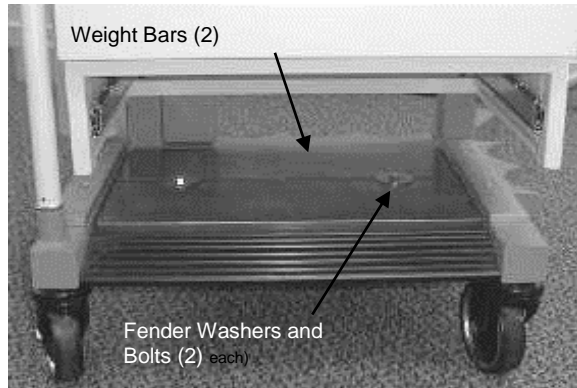

3. Attach the Cover to the top of the Rails, using the (4) #10-32 x 3/8" socket head cap screws.

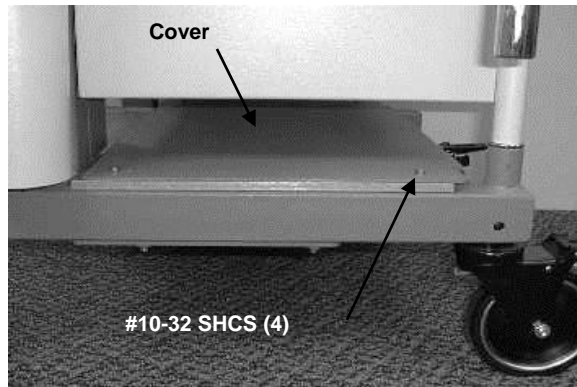

GS Secondary Counterweight Kit

1. Assembly is the same as above but insert a second pair of Weight Bars into the Lower Pan.

GS Top Plate with Cam Lock Rails

1. Place the painted top plate into the recess in the top of the anesthesia machine. Using the plate as a template, mark the top of the machine in the (6) locations indicated.

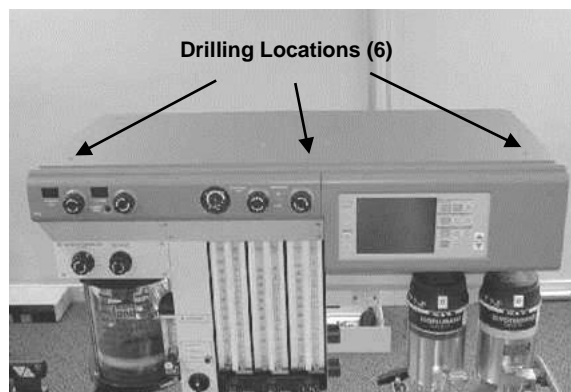

- Loosen the socket set screws (2 each side) to release the top of the machine. Lift up on the top of the machine and drill in the locations marked in step #1. Use a 1/4" diameter drill bit. Be careful not to drill too deeply, as damage to internal components of the machine could result. Remove all drilling chips.

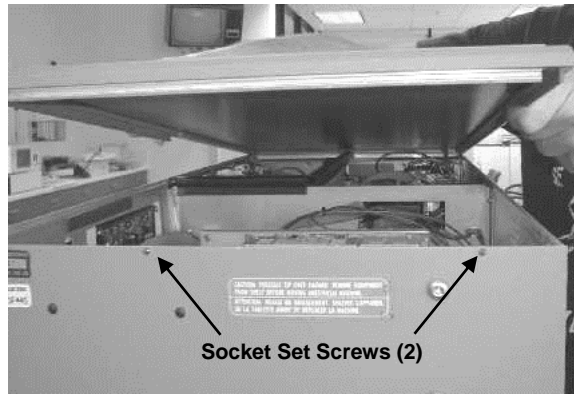

- Run the (6) #10-32 x 3/4" flat head machine screws through the top plate and into the holes drilled in step #2. Tighten the (6) #10-32 kep nuts onto the bottom of the screws. Reassemble the top of the anesthesia machine.

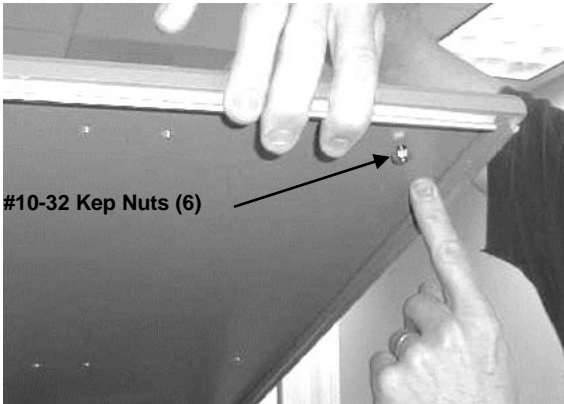

AGM Installation to the Top-Shelf Cam Lock Plate

- Insert the front edge of the AGM Feet to the front and rear Cam Lock Rails.



2. Secure the AGM to the Top-Shelf Plate by moving the AGM Cam Lock Lever as shown.

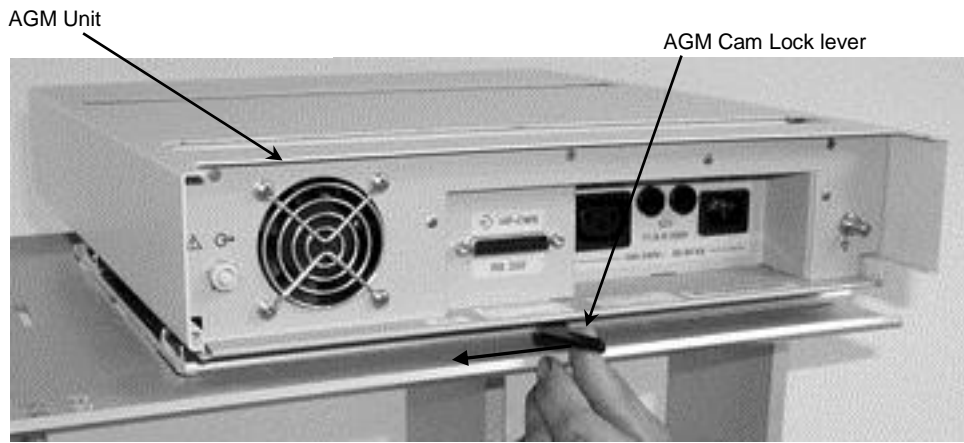



WARNING: USE OF MOUNTING HARDWARE AND MONITORING COMPONENTS OTHER THAN THOSE DESCRIBED IN THIS DOCUMENT MAY RESULT IN SERIOUS INJURY DUE TO TIPPING OF THE ANESTHESIA MACHINE.

Parts Reference

The parts list below includes parts and hardware that will be used in this installation procedure (see photos for parts; hardware not shown).

Item #	Description	Qty
1	Camlock Mount Assembly	1
2	M6 x 12mm Flat Head Machine Screw (FHMS)	1
3	M6 x 8mm FHMS	2
4	M4 x 20mm PHMS	2
5	#6-32 x 1/2" PHMS	1
6	5/32" Hex Key	1
*7	Spacer	1
*8	M6 x 16mm Pan Head Machine Screw (PHMS)	2

*See non-Table Mount" on page 3 for use of these parts.

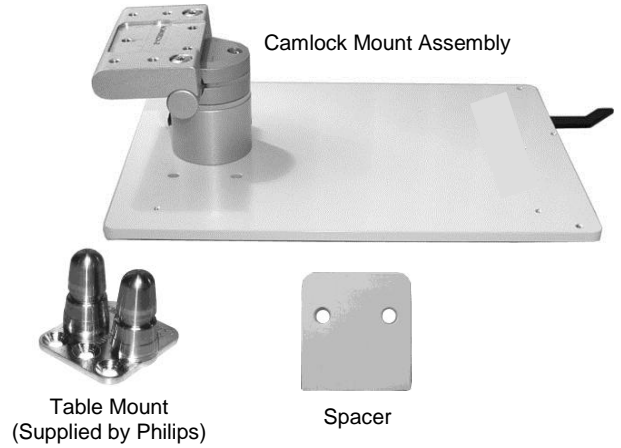

Tools Required: Phillips screwdriver (not provided), and 5/32" [4mm] hex key (provided).

Installation Note: Do not attach the Philips-supplied Table Mount to the Mounting Adapter on the Camlock Mount if you will be mounting a monitor equipped with the mounting interface shown in photo below. See "Non-Table Mount" (page 4) for instructions specific to this type of mounting plate.

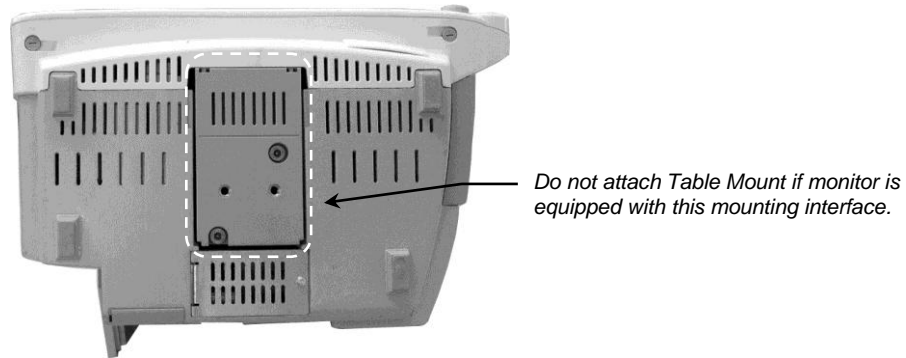

Attaching the Table Mount to the Mounting Adapter

Installation Note: Table Mount is supplied by Philips.

1. Fasten Table Mount to Mounting Adapter on Monitor Mount with one (1) M6 x 12mm FHMS and two (2) M6 x 8mm FHMS (see below).

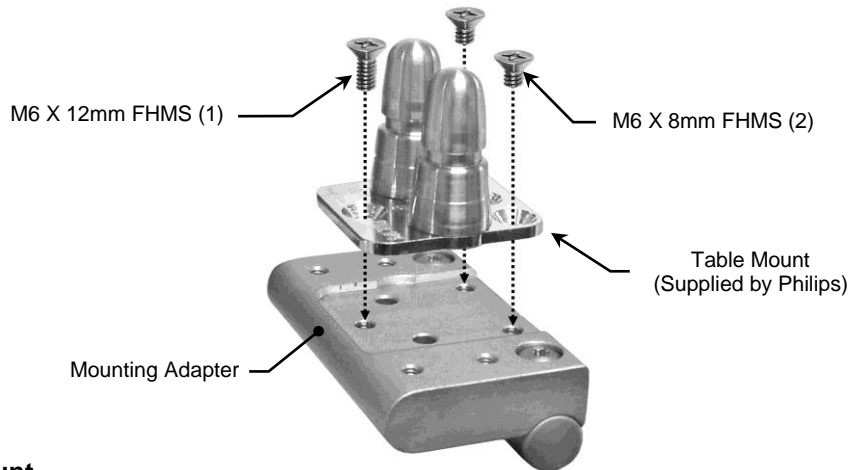

Mounting the Camlock Mount

1. Insert the four (4) feet (bottom of Camlock Mount) into the camlock channels (channels on top of AGM shown below).
Installation Note: Camlock Lever must be in the "unlocked" position when mounting feet in channels. After inserting the feet, lock the Mount in place by moving the Camlock Lever from right to left (below right).

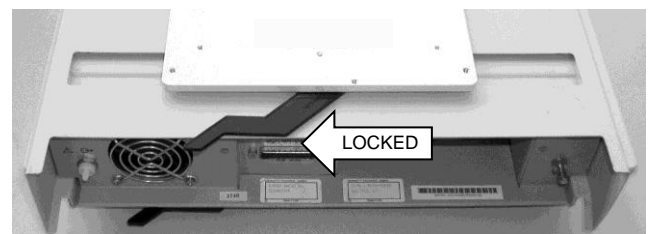
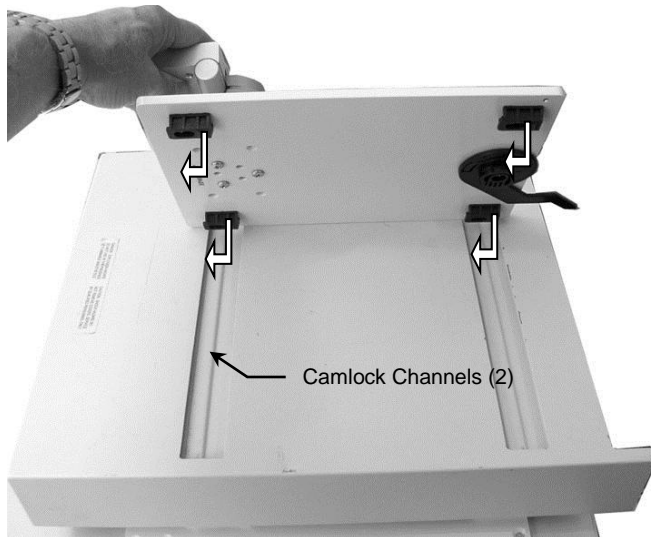

2. To prevent the Camlock Lever from being unlocked, insert one (1) #6-32 x 1/2" PHMS in the threaded hole to the right of the Lever (below). Insert one (1) M4 x 20mm PHMS in each of the two (2) threaded holes at the rear corners of the Mount (below). Stop tightening these screws when they make contact with the bottom of the channel.

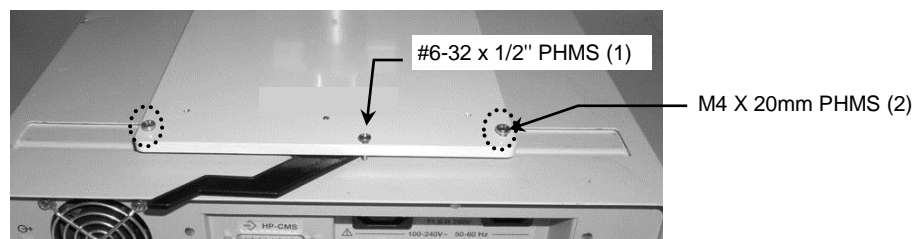

Mounting the Monitor

Table Mount

Mount the monitor in accordance with the Philips Table Mount instructions.

Non-Table Mount

1. Tilt Mounting Adapter on Camlock Mount upward as far as possible.

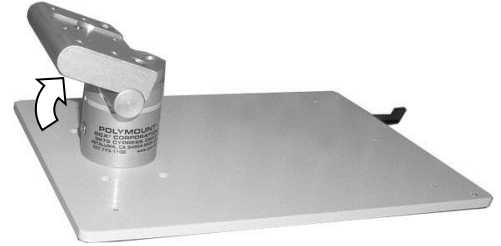

2. Turn monitor upside down. Align Spacer with corresponding mounting holes on bottom of monitor as shown below.
Installation Note: Ensure that the end of the Spacer with rounded corners is facing the front of the monitor.

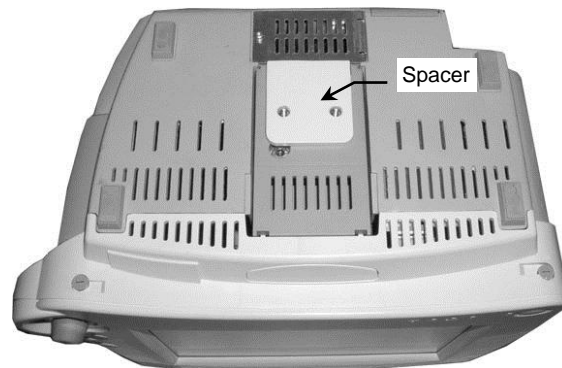
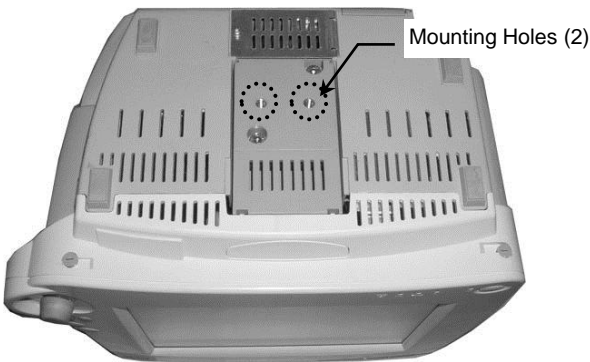

3. Turn Camlock Mount upside down and align Mounting Adapter with corresponding mounting holes in Spacer and monitor. Thread two (2) M6 x 16mm through bottom of Mounting Adapter and into mounting holes in bottom of monitor, ensuring that the Spacer remains between Mounting Adapter and monitor. Adjust tilt tension as necessary. See *"Tilt and Swivel Tension Adjustments"* on page 4.

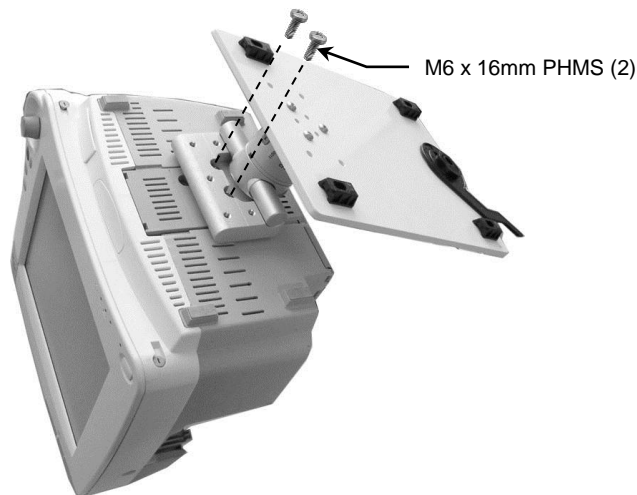

4. Mount monitor/Camlock Mount assembly as described in *"Mounting the Camlock Mount"* on page 2.

Mounting the MX400/450/500/550 Monitor (Fixed Mount Adapter)

Mount the monitor in accordance with separate Installation Guide DU-PH-0073-15 provided with the Mounting Adapter, ordered separately.

Tilt and Swivel Tension Adjustments

Tilt tension is adjusted by tightening or loosening the socket-head screw on the top of the Mount. A 5/32" hex key is provided for this adjustment.

Installation Note: This adjustment should be made while the monitor is mounted.

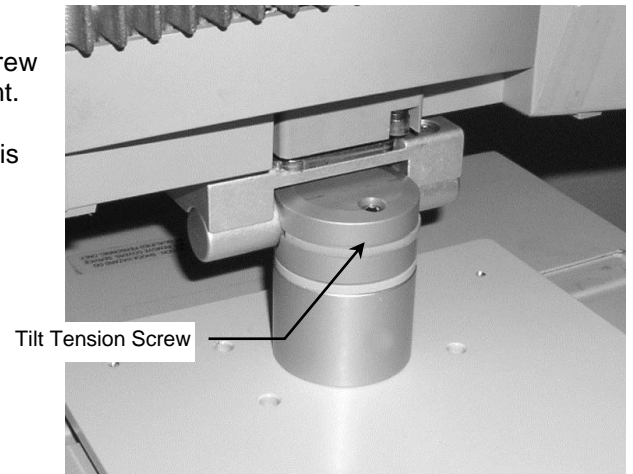

Swivel tension is adjusted by tightening or loosening the screw on the side of the column.

Installation Note: This adjustment should be made while the monitor is mounted.

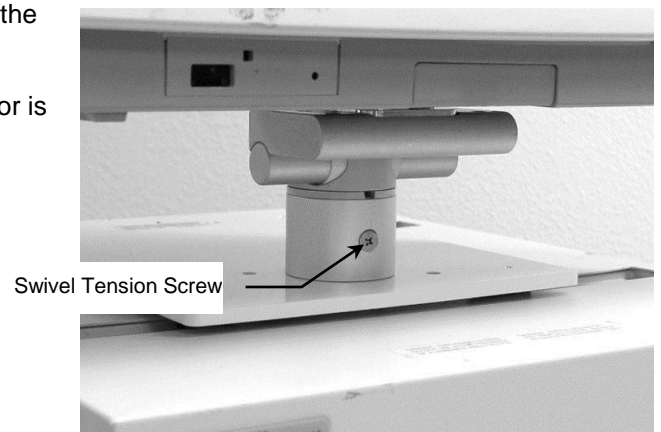

MX400/450/500/550

Fixed Mount Adaptor: Mount the monitor in accordance with separate Installation Guide DU-PH-0073-15 provided with the Mounting Adapter, ordered separately

GS Side Channel Mounted to Left Side of the Machine

1. Locate the (2) 5/16-18 mounting holes in the left side of the upper portion of the anesthesia machine. Attach the Channel using the (2) 5/16-18 x 3/4" button head socket head cap screws included.

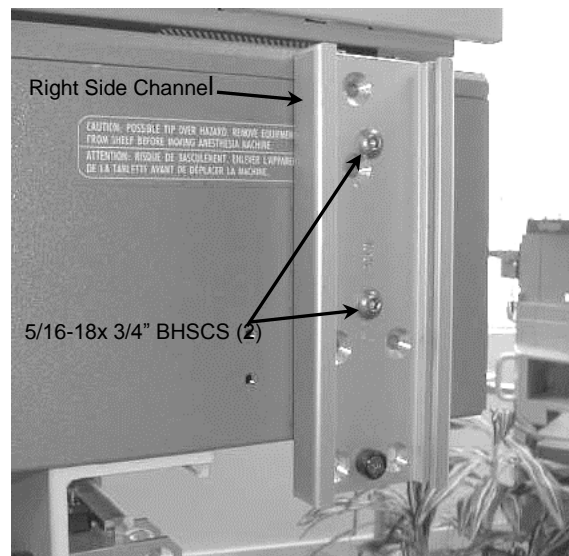
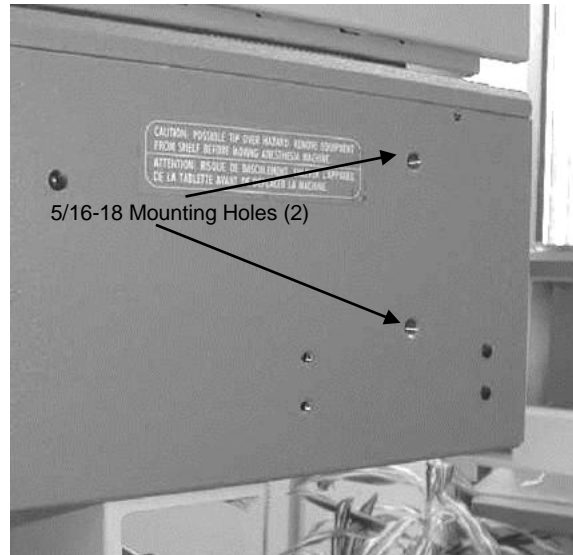

Flexible Module Server on M-Series Pivot Arm

1. Set the M-Series Pivot Arm with Down Post at the bottom of the Channel to provide space for the M-Series Pivot Arm holding the Philips Patient Monitor. Secure the Arm in the Channel by tightening the (2) 1/4-20 x 3/4" SSS in the Slide.

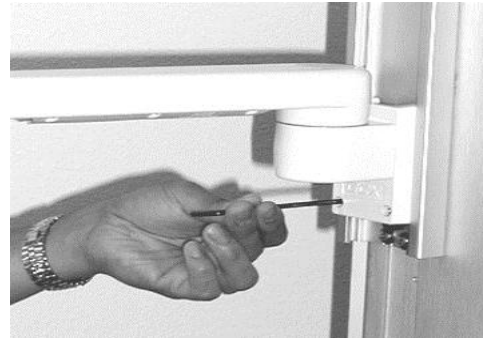
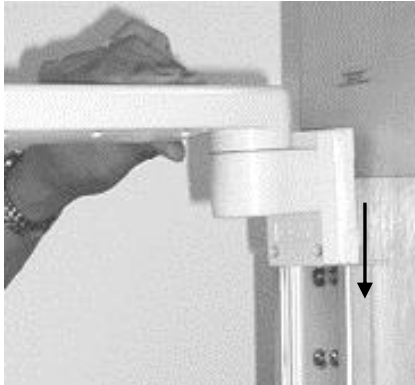

2. Align the screw holes in the Down Post with the threaded holes on the Swivel Fitting. Using the supplied 5/32 (4 mm) hex key and secure the 10-32 x 3/8" SHCS (3).

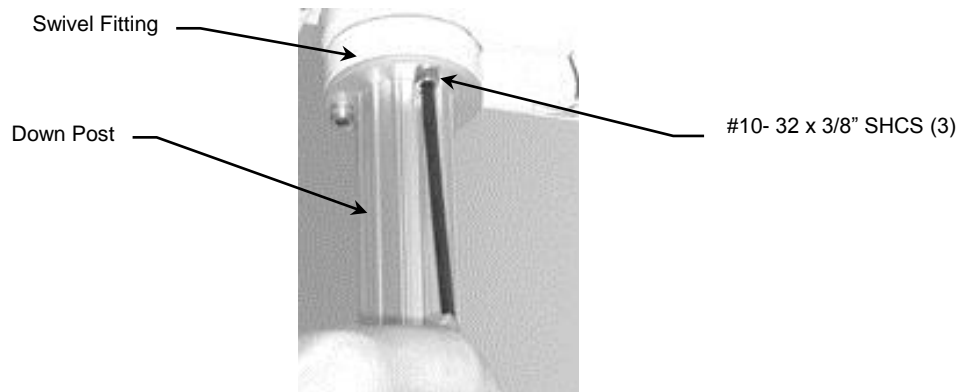

3. Attach the Flexible Module Server to the Down Post by placing the Clamp around the Down Post and tightening the knob.

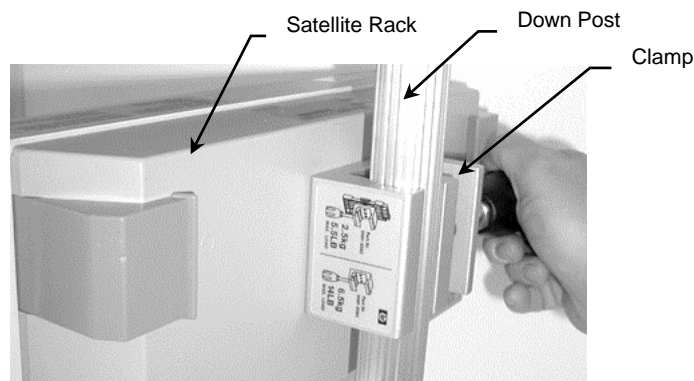

Adjustment and Operation of M Series Arm

Positioning in the Channel

WARNING: Never attempt to remove the mounting assembly from the Channel when loaded with a device.

1. Loosen the (2) 1/4-20 x 3/4" SHCS set screws in the Slide.
2. To raise or lower the Arm in the Channel, relieve the weight of the mounted device by lifting against the underside of the Arm, near the device. Simultaneously, push up or pull down the opposite end of the Arm just in front of the Slide.

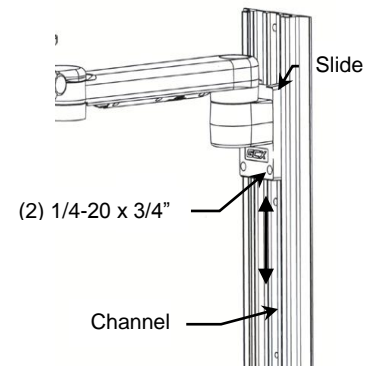

Pivot

1. To pivot at the Slide, simply push on the side of the Arm or mounted device.
2. To adjust the pivot tension at the Slide, use a 1/2" (or 13 mm) socket driver to tighten or loosen the Pivot Tension Bolt to obtain the desired tension.

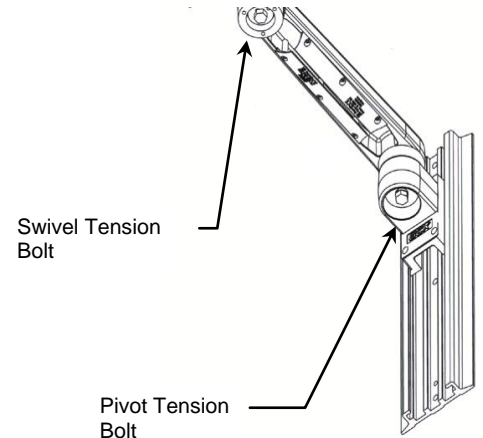

Swivel

1. In most configurations, the mounted device will swivel at the end of the Arm. To rotate the device simply push or pull the corners of the device.
2. To adjust the swivel tension, remove cap located under the front end of the Arm and use a 1/2" (or 13 mm) socket driver to tighten or loosen the Swivel Tension Bolt.

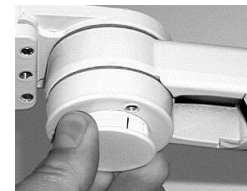

Cable Management

Two cable management features allow convenient placement and flow cables:

1. An open cavity beneath the arm with flexible cable covers manage cables going to and from the front and rear of the arm.
2. A "pass-through" channel slide allows cables to run behind the arm within the Channel. **Note:** If cable connectors are too large to fit through the pass-through, try placing the cables in the path of the Slide before installing the arm in the Channel. Contact GCX for optional Channel Covers available to further manage the flow of cables in the Channel.

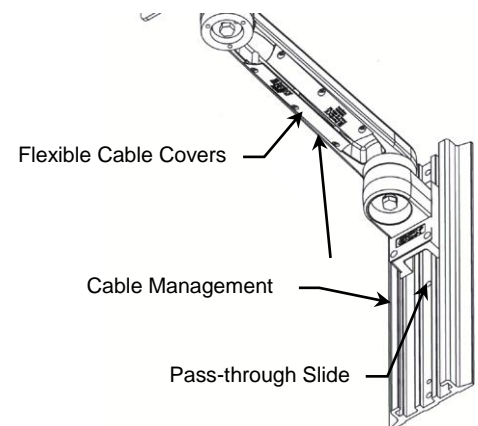

CLEANING

1. The mounting assembly may be cleaned with most mild, non-abrasive solutions commonly used in the hospital environment (e.g. diluted bleach, ammonia, or alcohol solutions).
2. The surface finish will be permanently damaged by strong chemicals and solvents such as acetone and trichloroethylene.
3. Steel wool or other abrasive material should *never* be used.
4. Damage caused by the use of unapproved substances or processes will not be warranted. It is recommended that you test any cleaning solution on a small area of the arm that is not visible, to verify compatibility.
5. Never submerge the arm, and do not allow liquids to enter the arm. Wipe any cleaning agents off of the arm immediately, using a water-dampened cloth. Dry the arm thoroughly after cleaning.

CAUTION: GCX makes no claims regarding the efficacy of the listed chemicals or processes as a means for controlling infection. Consult your hospital's infection control officer or epidemiologist. To clean or sterilize mounted devices or accessory equipment, refer to the specific instructions delivered with those products.