

## Installation Guide

### Philips Intellivue MP90 Installation Kit for Dräger Apollo Anesthesia Machine

The purpose of this guide is to describe installation of mounting assemblies on the anesthesia machine.



**WARNING:** USE OF MOUNTING HARDWARE AND MONITORING COMPONENTS OTHER THAN THOSE DESCRIBED IN THIS DOCUMENT MAY RESULT IN SERIOUS INJURY DUE TO TIPPING OF THE ANESTHESIA MACHINE.

**WARNING:** ALL DEVICES AND MOUNTING EQUIPMENT SHOULD BE POSITIONED INWARD, CLOSE TO THE ANESTHESIA MACHINE, DURING TRANSPORT.

**Installer:** When installation is completed, provide these instructions and all related documentation to the end user for future reference.

#### Mounts for MP90 Equipment

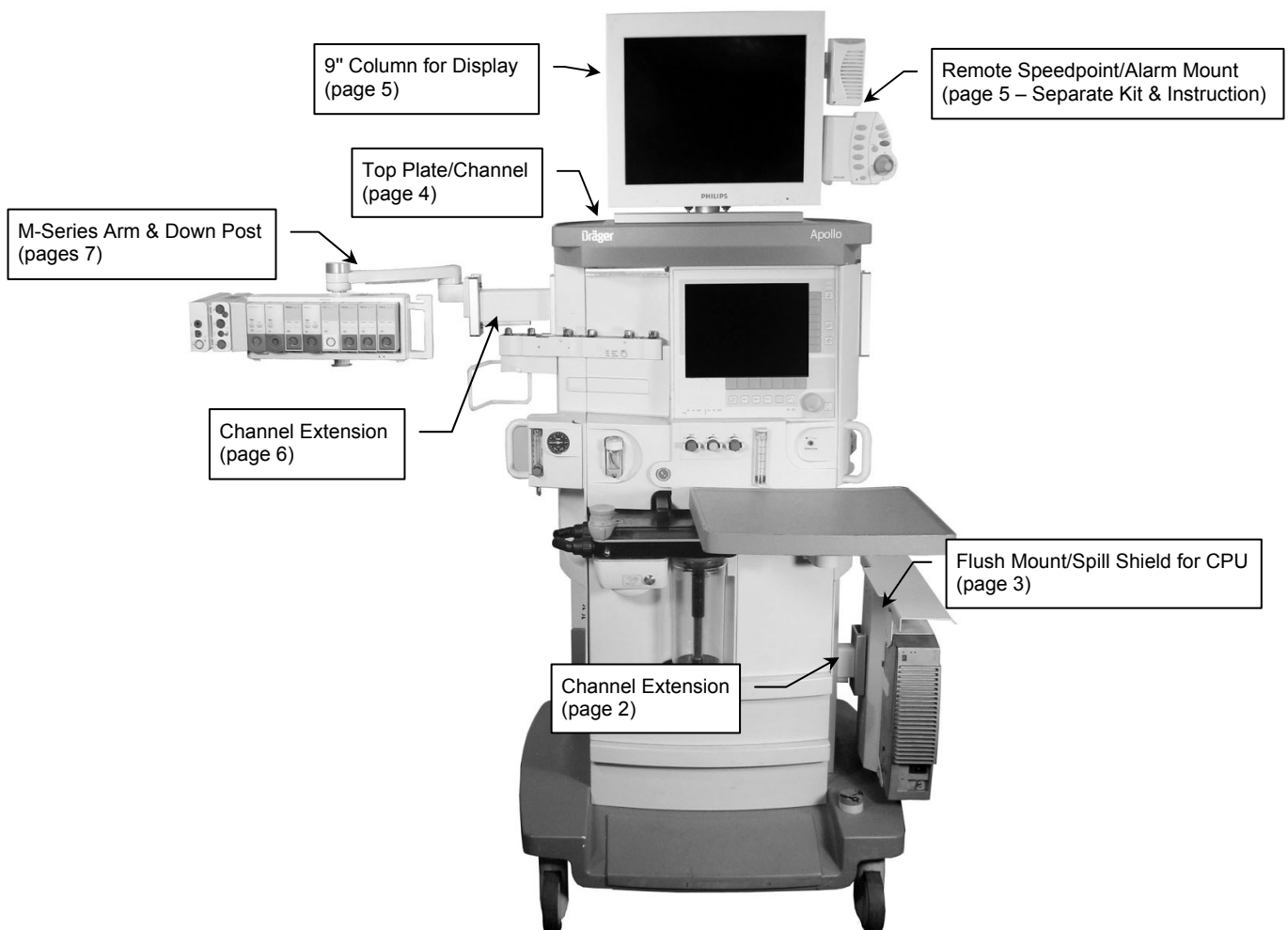

## Mounting CPU in Right Side Channel

The following parts and hardware will be used in this installation (hardware not shown):

Item #	Description	Qty
1	Channel Extension	1
2	Adjustable Stop (not shown)	1
3	Mounting Pan/Spill Shield Kit (includes hardware)	1

### Tools required

- Phillips screwdriver (not provided)

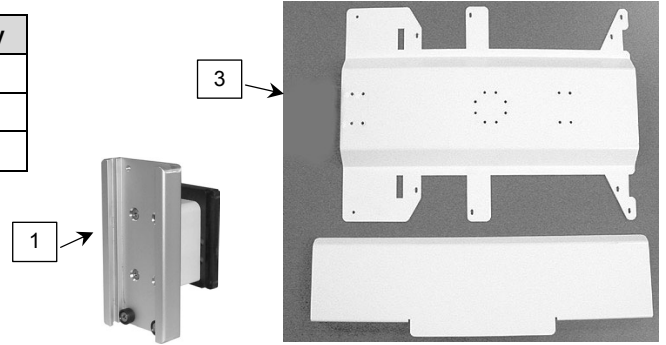

1. Install Adjustable Stop 3.5" below opening in channel as shown below left.
2. Install Channel Extension in channel opening and guide to rest against Adjustable Stop as shown below right.

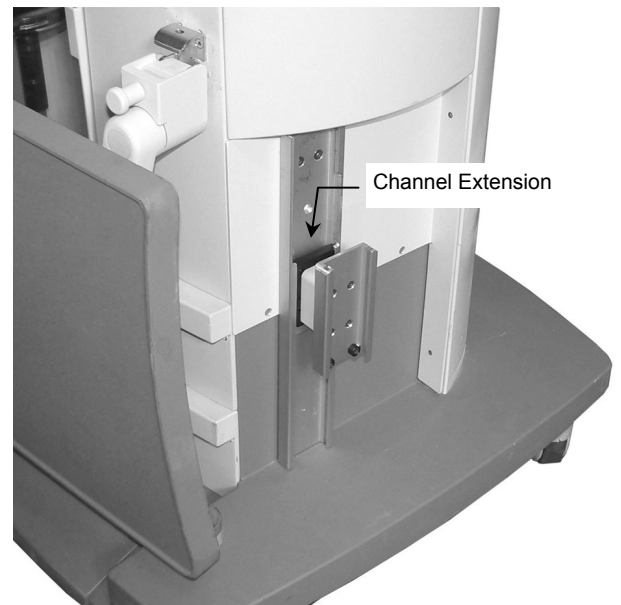
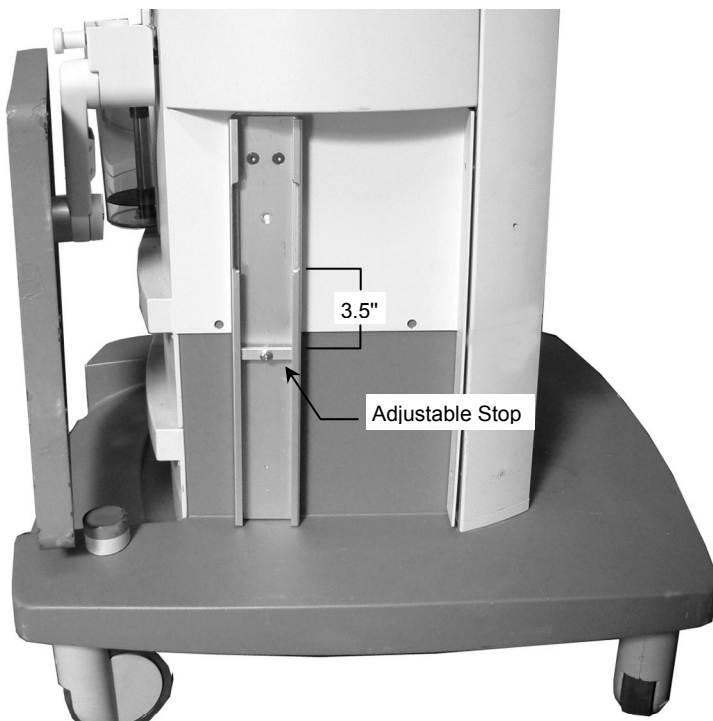

3. Attach Mounting Pan /Spill Shield to CPU in accordance with installation guide included with the CPU Mounting Kit. Channel Slide must be attached to Mounting Pan in center mounting pattern as shown below left.
4. Insert Channel Slide (rear of CPU) in Channel Extension and carefully guide CPU to rest against Adjustable Stop as shown below right.

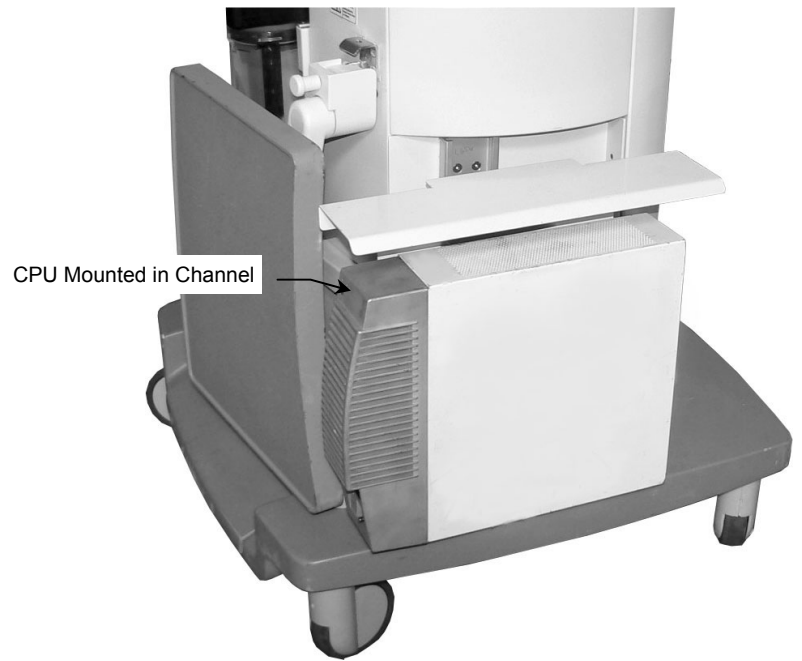
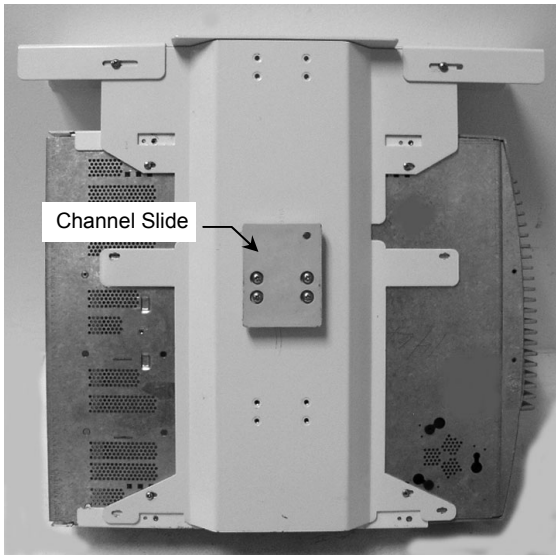

## Attaching Top Plate/Channel to Top of Apollo

The following parts and hardware are included in this installation kit (hardware not shown):

Item #	Description	Qty
1	Top Plate/Channel Assembly	1
2	M4 x 10 mm Flat Head Machine Screw (FHMS)	1

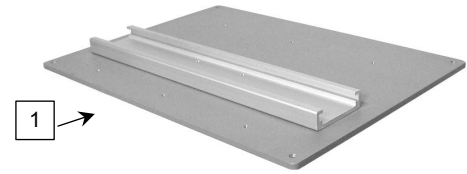

**Tools required:** Phillips screwdriver (not provided)

## Installing the Top Plate/Channel

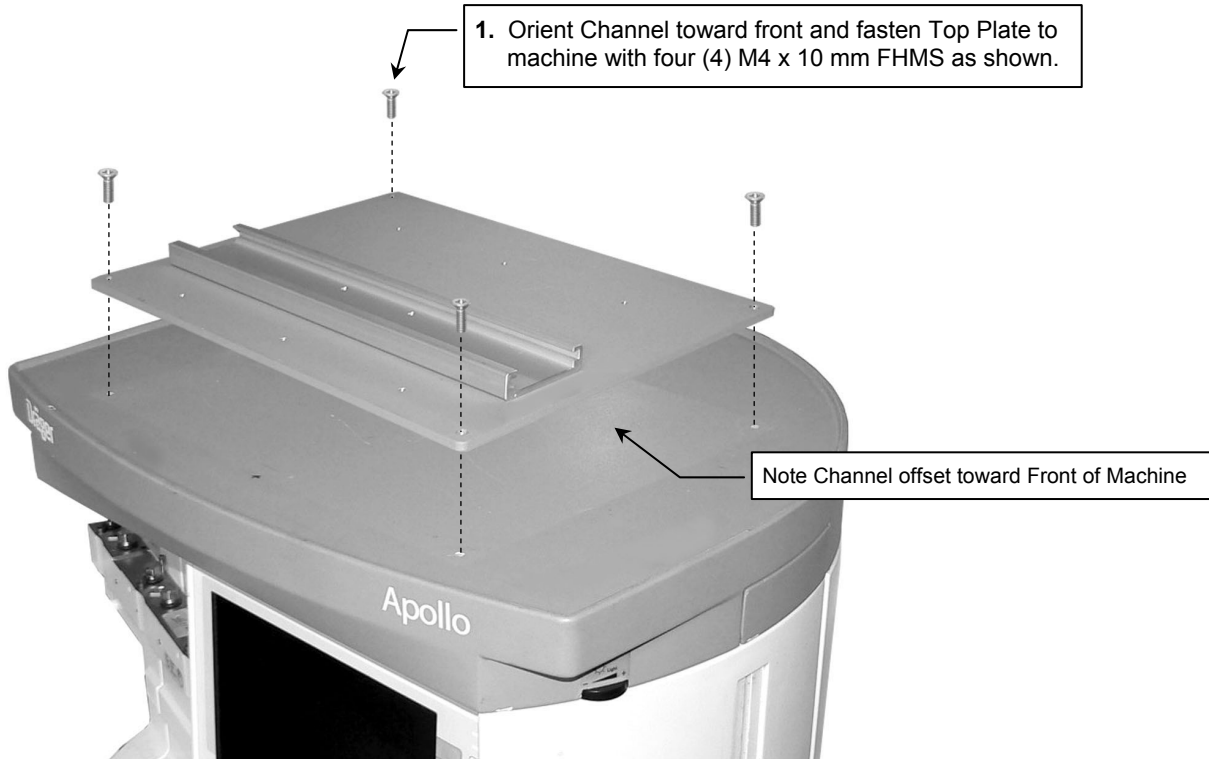

## Mounting 9" Tilt/Swivel Column in Channel

The following parts and hardware are included in this installation kit (hardware not shown):

Item #	Description	Qty
1	Tilt/Swivel Column, 9" with VESA Mounting Plate	1
2	5/32" Hex Wrench (for tilt tension adjustment)	1



**Tools required:** 5/32" hex wrench (provided for tension adjustment).

1. Slide Base Plate into channel and move to desired mounting position.
2. Tighten two (2) thumb screws to secure position in channel.

Move to Mounting Position and Tighten Thumb Screws (2)

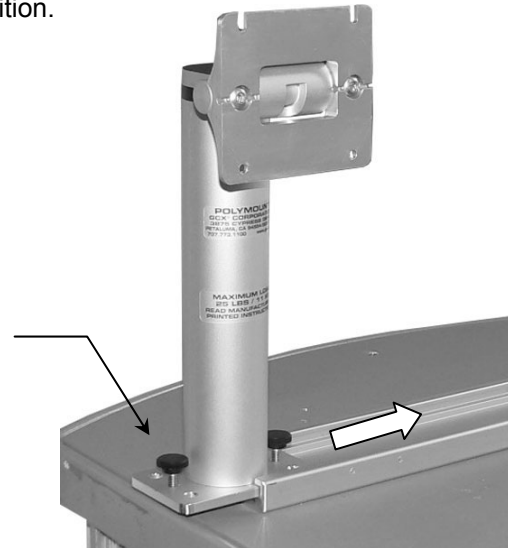

## Mounting the Display, Remote Speedpoint, External Alert Device, and Power Supply (not shown)

Mount the display, remote speedpoint, external Alert device, and power supply (if applicable) in accordance with separate installation guide titled "*Philips MP90 Remote Speedpoint Mounting Bracket and Adapter, and External Alert Device Mounting Bracket*" (DU-AG-0019-80). All parts and hardware are included in separate installation kit.



## Mounting Extension Channel in Left Side Accessory Track

The parts list below includes parts and hardware that will be used in this installation procedure (hardware not shown).

Item #	Description	Qty
1	6" Channel Extension	1
2	Nut Plate	2
3	M6 x 25mm Flat Head Socket Cap Screw (FHSCS)	2
4	5/32" Hex Wrench	1

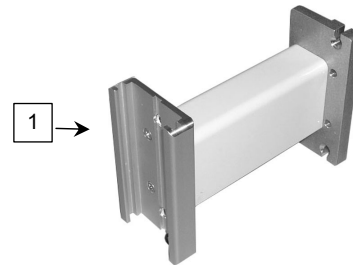

**Tools required:** 5/32" hex wrench (provided).

1. Thread one (1) M6 x 25mm FHSCS a few turns into each Nut Plate, leaving 20mm of thread exposed per screw (below left).
2. Insert Nut Plate/screw assemblies in top and bottom slots as shown below right.

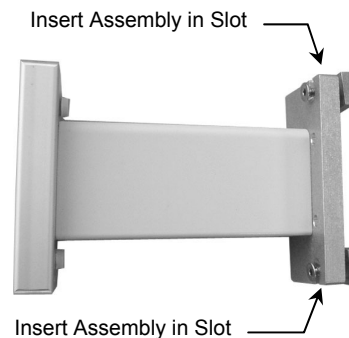
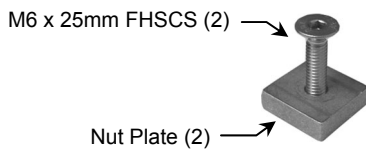

3. Hold Nut Plate/Screw assemblies in position (below left) while guiding Nut Plates into accessory track. Move entire assembly up the track to desired mounting position.
4. Using the 5/32" hex wrench provided, tighten bottom screw first, then top screw (below right).

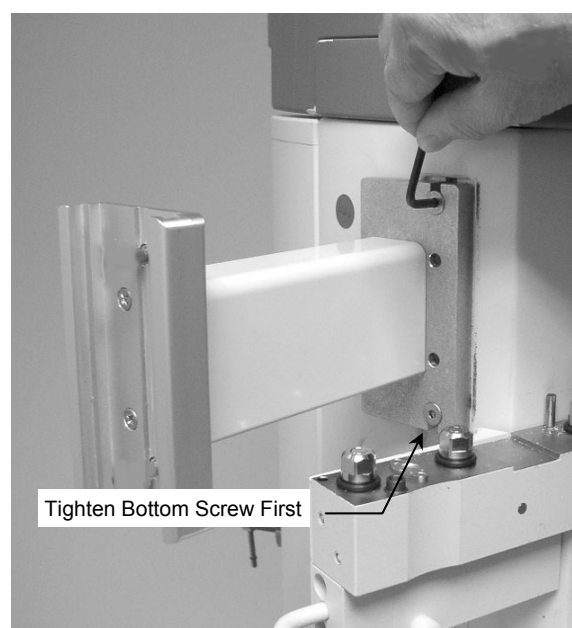
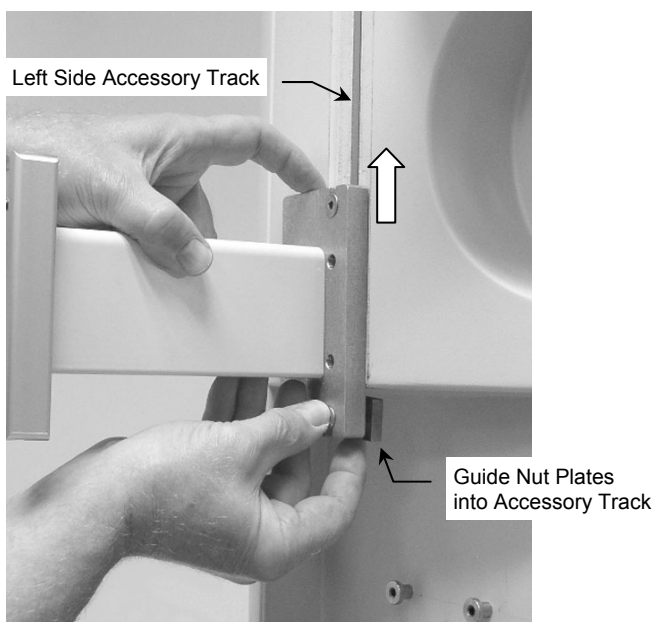

## Installing Arm in Channel

The following parts and hardware are included in this installation kit (hardware not shown):

Item #	Description	Qty
1	12" M-Series Arm	1
2	Down Post, 6"	1
3	#10-32 x 3/8" Socket Head Cap Screw (SHCS)	3
4	1/8" Hex Wrench	1
5	5/32" Hex Wrench	1

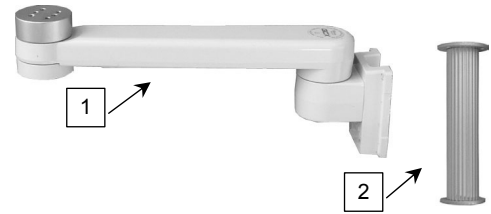

**Tools required:** 5/32" hex wrench (provided), 1/8" hex wrench (provided)

1. Using the 5/32" hex wrench provided, fasten Post to Swivel Cup with three (3) #10-32 x 3/8" SHCS as shown below.
2. Insert Slide (rear of Arm) in opening in top of channel and carefully lower Arm to rest at bottom of channel. Using the 1/8" hex wrench provided, tighten two (2) socket set screws to secure position in channel.

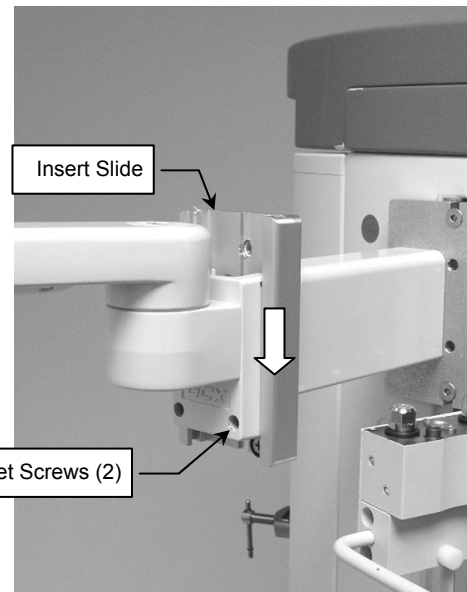
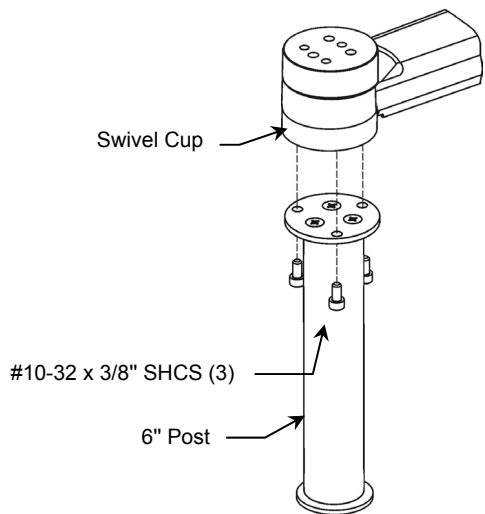

## Mounting FMS on Down Post

Follow Philips instructions for mounting FMS on Down Post. A Philips-supplied clamp is required for this installation.

**Installation Note:** The clamp on the rear of the FMS may be rotated 90° to allow vertical mounting of the FMS as shown below right.



## Adjusting Tilt Tension

**Tilt Tension:** Adjust overall tilting tension by evenly tightening or loosening two (2) tilt tension screws with the 5/32" hex wrench provided. Once overall tilt tension is set, use Tilt Adjustment Lever to fine tune/lock tilt position.

**Tilt Adjustment:** Turn Tilt Adjustment Lever counterclockwise (CCW) to loosen. Lever provides ratchet-style adjustment (see **Note** below). Grasp the display and tilt to desired angle. Turn Tilt Adjustment Lever clockwise (CW) to tighten and lock position.

**Note:** The Tilt Adjustment Lever is a multi-position clamping lever that operates by lifting, rotating, and releasing the handle.

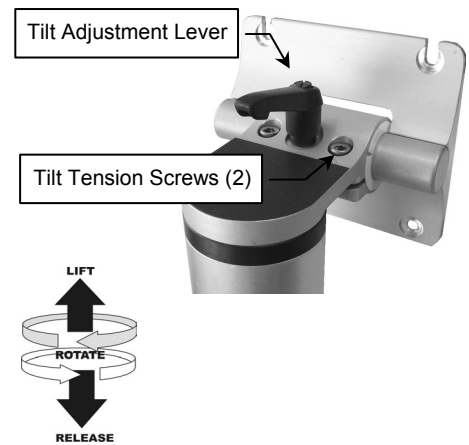

## Periodic Maintenance

All fasteners associated with the mounting system should be inspected periodically and tightened or adjusted as necessary for optimal operation and safety.

## Cleaning the Mounting Assembly

**CAUTION:** GCX makes no claims regarding the efficacy of the listed chemicals or processes as a means for controlling infection. Consult your hospital's infection control officer or epidemiologist. To clean or sterilize mounted devices or accessory equipment, refer to the specific instructions delivered with those products.

1. The mounting assembly may be cleaned with most mild, non-abrasive solutions commonly used in the hospital environment (e.g. diluted bleach, ammonia, or alcohol solutions).
2. The surface finish will be permanently damaged by strong chemicals and solvents such as acetone or trichloroethylene.
3. Steel wool or other abrasive material should never be used.
4. Damage caused by the use of unapproved substances or processes will not be warranted. We recommend testing of any cleaning solution on a small area of the arm that is not visible to verify compatibility.
5. Never submerge or allow liquids to enter the arm. Wipe any cleaning agents off the arm immediately using a water-dampened cloth. Dry mounting assembly thoroughly after cleaning.